



**Look your Best!**

**2017-2018**

**Catalog and Pricing**

PRICING EFFECTIVE AUGUST 1, 2017 - JULY 31, 2018

**Providing quality marketing resources to  
the nursery industry for over 50 years!**



## Look your Best!

You can't go wrong when you add experience, quality and service to your team. We can help you do just that. Whether you're looking for high quality Standard tags, a colorful custom look or a flexible service package Macore can help you. Call us today and let's begin an exciting partnership!

The Macore Team

## Contents

	Standard Stakes	3-9
	Standard & Custom Basket Tags	10-13
	Ball Wave Tags	14-15
	Pack Handles	16-19
	Standard Push-On Tags	20-21
	Standard Hang Tags	22-23
	Seasonal/Specialty Tags	24-27
	Custom Tags & Labels	28-3
	Utility Labels with Black Ink	34-37
	Blank, Production Aids & Retail	38-43



You now have options for Standard stakes that also have a rich, colorful design. Macore provides 6 different Standard styles/art on 5 different sizes. You can use these combinations with any group of varieties you grow. Consider that:



**6** Styles **5** Sizes

- All sizes are made with thick 19pt.-20pt. styrene.
- Options range from 4 ½”-7 ¾” tall.
- All stakes have helpful creasing, making them sturdier.
- Full-color art, plant data and photos come with each style.
- We have a large photo and variety data library.
- Modifications with UPCs, logos, grown by phrase and other options are possible with any standard stake (see page 8 for illustrations).

Look your best with this very flexible stake line up.



**Wave Top  
Style A**

**Round Top  
Style B**

**Bubble Top  
Style C**



Flat Top  
Style D

Vegetable  
Style E

Herb  
Style E

*Hemerocallis*  
Stella d'Oro

*Gazania*  
Big Kiss™ Yellow Flame

PERENNIAL  
Beautiful Cut Flower

*Hellebores*  
Winter Jewels™  
Golden Lotus

PERENNIAL  
Attractive Border Plant!

*Hosta*  
Fire and Ice

PERENNIAL  
Attractive Border Plant!

*Vinca*  
Sterling Silver  
Periwinkle

PERENNIAL  
Evergreen Plant!

Chocolate  
Stripes Tomato

VEGETABLE

Diva Cucumber

VEGETABLE

Burning Bush  
Pepper

VEGETABLE

Rhubarb  
Swiss Chard

VEGETABLE

Jack-Be-Little  
Pumpkin

VEGETABLE

Barbecue Rosemary

HERB

Emerald and  
Gold Mint

HERB

Lemon Balm

HERB

Roman  
Chamomile

HERB

Dark Opal Basil

HERB

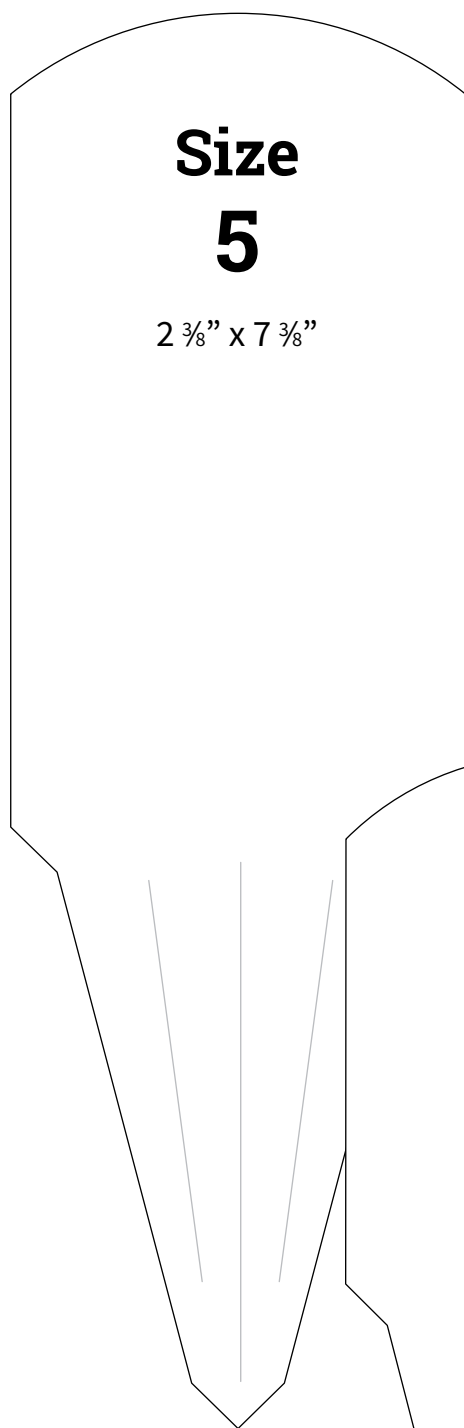

**Size  
5**

2 3/8" x 7 3/8"

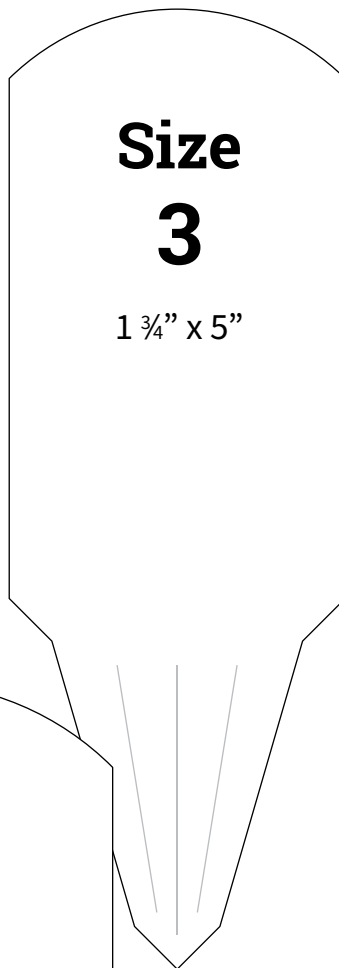

**Size  
3**

1 3/4" x 5"

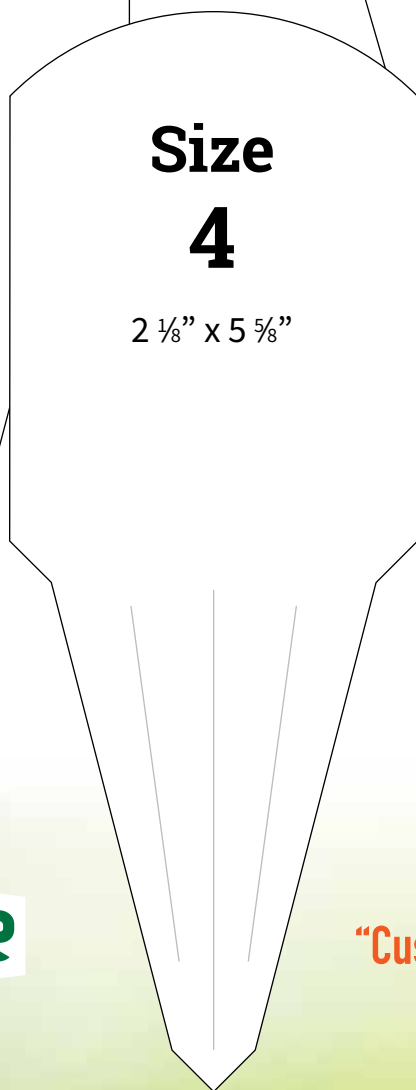

**Size  
4**

2 1/8" x 5 5/8"

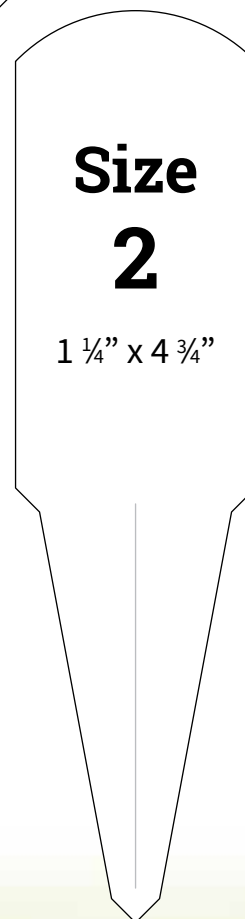

**Size  
2**

1 1/4" x 4 3/4"

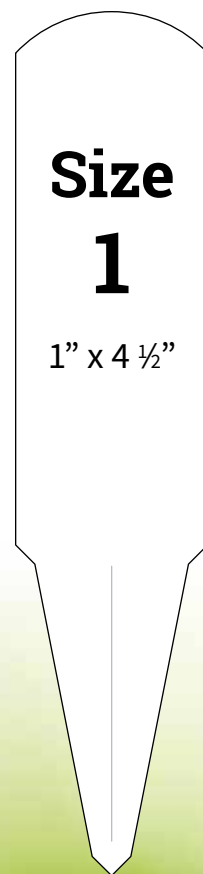

**Size  
1**

1" x 4 1/2"

All sizes and styles are available at the prices shown for the varieties in our Herbaceous lister.

Non-lister varieties in your order will match the style/size you select.

Different styles of the same size cannot be mixed for combined price.



**"Customers love their durability."**

*Judith -  
Fancy Fronds Nursery  
30 year customer*

## Size 1

(All standard styles)

1" x 4 1/2"

QUANTITY	PRICE PER 1000
<8,500	\$37.20
8,500	\$24.80
17,000	\$24.25
34,000	\$23.35
68,000	\$23.20
102,000	\$22.70

## Size 2

(All standard styles)

1 1/4" x 4 3/4"

QUANTITY	PRICE PER 1000
<6,500	\$59.80
6,500	\$47.10
13,000	\$46.05
26,000	\$40.20
52,000	\$39.95
78,000	\$38.05

## Size 3

(All standard styles)

1 3/4" x 5"

QUANTITY	PRICE PER 1000
<6,000	\$110.45
6,000	\$ 90.20
12,000	\$ 87.90
24,000	\$ 76.50
48,000	\$ 71.75
56,000	\$ 66.60

## Size 4

(All standard styles)

2 1/8" x 5 5/8"

QUANTITY	PRICE PER 1000
<5,000	\$114.45
5,000	\$ 94.60
10,000	\$ 87.80
20,000	\$ 76.40
40,000	\$ 73.10
60,000	\$ 69.15

## Size 5

(All standard styles)

2 3/8" x 7 3/8"

QUANTITY	PRICE PER 1000
<3,000	\$190.05
3,000	\$155.65
6,000	\$145.85
12,000	\$126.85
18,000	\$118.85
36,000	\$113.55

**Look your Best!**

**Call us for a quote  
on large quantities  
or custom orders!**

All tags require 500 per variety multiple.

Different styles of same size cannot be mixed for combined price (round top style B, and VE tags can combine for price).

\$15.00 handling fee for orders under \$200.00.

Unless paid at the time of order placement, orders paid for by credit card will receive a 3% surcharge.



All prices F.O.B. from Lafayette, Oregon. Prices subject to change without notice.

## Modified Standard Stakes

Often a grower needs minor modifications made to their Standard stakes/labels. These modifications help inform consumers about their product and the grower. See these sample illustrations below of possible modifications.

We can also change a background color or make a minor text change. Your call to us today is the first step to having a unique, personalized tag in your product!



Call us today  
for sample proofs!

## Look your Best!

### Add grown by information

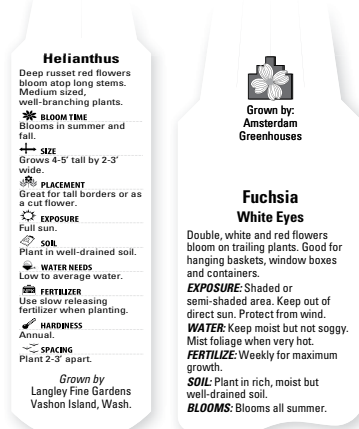

### Add weights & measures



### Add your logo



### Add a UPC





# Custom Stakes from Standard Shapes

You can build a strong custom program using any of our Standard tag shapes. This can simplify the process of establishing your brand in the marketplace. You can bring us your own art design or work with the Macore art team to create a custom design (see page 28).

**Call us today to explore this option!**



# Standard Basket Tags

Present your product with the style and beauty it deserves. Macore has standard and premium tag options for your hanging baskets. Our standard basket tags have:

- Colorful artwork
- Assorted picture options
- Can be modified
- Printed on strong HDPE
- Multiple attaching methods (other custom shapes & styles available)

Your customers will be impressed with a Macore tag on your baskets!

## STANDARD H1 & H2 ASSORTED ANNUALS PHOTOS

SUN

PART SUN

SHADE



# H1

1 13/16" x 4"

## SUN



VEGETATIVE ANNUAL MIX  
Assorted Annuals

## PART SUN



VEGETATIVE ANNUAL MIX  
Assorted Annuals

## SHADE



VEGETATIVE ANNUAL MIX  
Assorted Annuals

See the  
Macore Basket  
Variety Lister  
for MORE  
variety photo  
options!

## H2

1 15/16" x 7 1/2"

### SHADE



### PART SUN



### SUN



See the  
Macore Basket  
Variety Lister  
for MORE  
variety photo  
options!

## Size H1

1 7/8" x 4"

QUANTITY	PRICE PER 1000
8,000	\$92.85
12,000	\$87.10
24,000	\$63.65
48,000	\$52.80

- 8,000 minimum total order.
- 4,000 total order multiples.

## Size H2

1 15/16" x 7 1/2"

QUANTITY	PRICE PER 1000
9,000	\$127.10
18,000	\$ 81.85
36,000	\$ 70.80
72,000	\$ 58.55

- 9,000 total order multiple/  
minimum.

- All tags require 500 per variety multiple.
- All Standard basket tags are printed in high quality color.
- \$15.00 handling fee for orders under \$200.00.
- Call us for a quote on large quantities or custom orders!
- Unless paid at the time of order placement, orders paid for by credit card will receive a 3% surcharge.



All prices F.O.B. from Lafayette, Oregon.  
Prices subject to change without notice.

## Custom Basket Tags

Both our H1 and H2 tags can be customized with your art design or one we develop for you. Our complete photo and variety information library is available for all custom orders. We can also use your photos and descriptions with any basket tag project.

If you need a full custom basket tag, Macore has been dressing baskets up for years! We can help you design both your art and tag shape for any program. Give us a call today – we're looking forward to helping you get just what you need to **Look your Best!**

**“Macore provides a very, very high level of service and quality”**

*Amanda Kamlade –  
Hart's Nursery*



**14" English Garden Basket**

**Solenia Begonia**

Outstanding flower displays in **Partial shade to full sun**

Water regularly and if possible in the morning, so that the foliage has a chance to dry before evening. Apply a slow release or water soluble fertilizer formulated for flowering plants at a moderate rate as per the fertilizer's instructions.

**Double Petunia Hanging Basket**



Large colorful blooms. Use basket to add color to decks, patios and porches. Blooms throughout the season. Prefers full sun to part shade. Keep soil moist, not wet.

**12" Premium Mixed Annual Basket**

*Sweet N'Sassy*

2.12 gal/8.04 L

**IWASAKI BROS.** 岩崎兄弟

**F&B FARMS AND NURSERY**

Colorful flowers bloom all season long. Place basket in sunny area, sheltered from the wind. Fertilize every week.

**Harts**

**Hawaiian Luau 10" Premium HB**

7 79599 87200 6

**10" Deluxe HB**

**SUN**

Get the free mobile app at <http://gettag.mobi>

**SUNTORY**

SUNTORY FLOWERS

**HILLTOP**

GREENHOUSES

**12" Calibrachoa HANGING BASKET**



6 28459 30027 6

**MEADOWBROOK GREENHOUSES INC.**

TOLL FREE 1 888 886 GROW

*Color your life*

**Petunia**

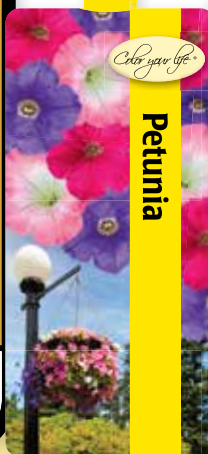

**ASHLAND GREENHOUSES**

**SUN**

**Petunia Surfinia®**

**10" HANGING BASKET**

**Tomato**

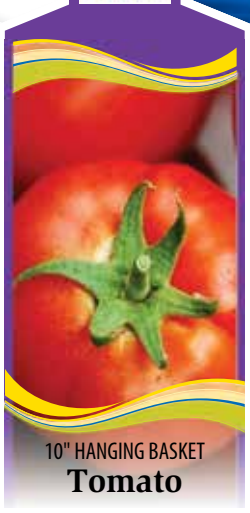

**STATE FAIR WINNER**



## Wave, Cool Wave and Plug & Play Tags

When you grow a highly desired product you want it to stand out in the marketplace.

Macore has been providing Wave branded marketing items to growers for years. We'll add limited modifications with Pan American's approval to help you and your retail clients. Let us apply our high standards to give this product line the attention it deserves.

Look your Best!

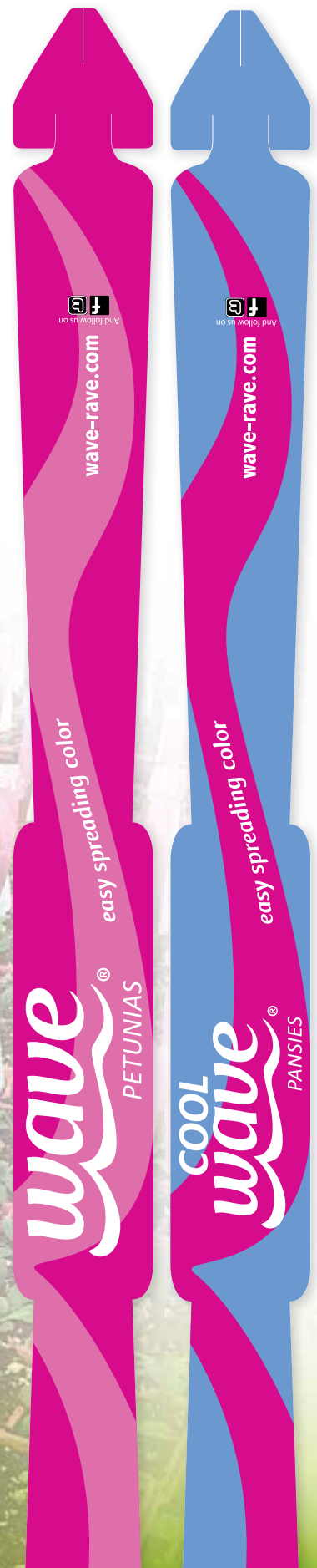

“Macore has tremendous flexibility with design work and order processing”

Becky Skiles –  
Spring Creek Garden

The image displays several plant tags for petunias. The tags include the following information:

- Wave Petunias:**
  - Easy Wave® Coral Reef:** "The best for baskets!"
  - Shock Wave® Coconut:** "Perfect for baskets & planters!"
- Cool Wave Petunias:**
  - Cool Wave® White:** "The fastest-growing, longest-lasting, truly trailing pansy"
  - Cool Wave® Violet Wing:** "The fastest-growing, longest-lasting, truly trailing pansy"
- Plug & Play:**
  - Lime Coral:** "Easy, grab 'n go combo for sun"
  - Lovin' It:** "Easy, grab 'n go combo for sun"

Additional text on the tags includes "easy spreading color", "PETUNIAS", "wave-rave.com", and "Join the Wave Fan Club at wave-rave.com".

# Handles that Hold

You'll see that Macore handles are designed to insert, grip and hold securely. Customers tell us they are sure performers. They are made of thick polypropylene with our unique tip insertion design. We can create a custom design or use your art files.

Contact us for a handle your retail customers can depend on.



**HNL1 is designed to fit the typical 306 Pack with 1/2"-size hole. Be sure handle sample works with your pack.**

**Look your Best!**



**"Macore has helped tremendously with improving our brand image"**

*Ketch de Kanter -  
Little Prince of Oregon Nursery*



# Standard Preprinted



Plant me where I can enjoy  
8 hours of sunlight.

Thanks for giving me  
4-8 hours of sun while avoiding  
hot afternoon locations.

Thanks for placing me in  
less than 4 hours of sunlight  
and no afternoon sun.

ASSORTED  
GROUND COVER

ASSORTED  
HERBS

Love the Sun!  
SUCCULENTS

COOL  
wave PANSIES  
easy spreading color

wave PETUNIAS  
easy spreading color

HNL1-01

HNL1-02

HNL1-03

HNL1-GC

HNL1-HB

HNL1-SU

HNL1-WA

HNL1-CW

## BHNL1

18<sup>3</sup>/<sub>4</sub>" x 1<sup>1</sup>/<sub>4</sub>"  
 Tip Width: 1<sup>1</sup>/<sub>4</sub>"  
 Neck Width: 1/2"

## BHNL2

**Restricted to the U.S. only**  
 18<sup>3</sup>/<sub>4</sub>" x 1<sup>1</sup>/<sub>8</sub>"  
 Tip Width: 1.0"  
 Neck Width: 7/16"

## BHNL3

18<sup>3</sup>/<sub>4</sub>" x 3/4"  
 Tip Width: 3/4"  
 Neck Width: 3/8"

**Be sure handle  
 insertion dimensions  
 work with your pack  
 size. Call us for  
 a sample!**

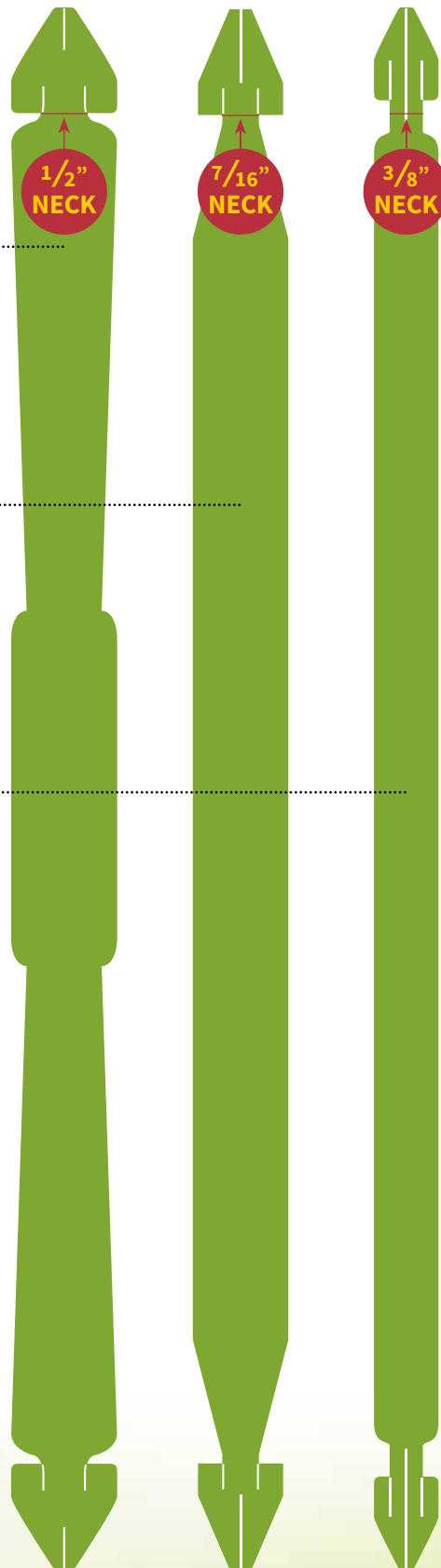

All prices F.O.B. from Lafayette, Oregon.  
 Prices subject to change without notice.

## STANDARD PREPRINTED

(HNL1 - Images on Pages 16-17)  
 .020 Polypropylene

QUANTITY	PRICE
<5,000	\$31.00/ 100
5,000	\$258.15/1000
25,000	\$187.75/1000

## BHNL1

(Blank)  
 .020 Polypropylene

QUANTITY	PRICE
100	\$ 22.30/ 100
1,000	\$148.80/1000
10,000	\$133.90/1000

## BHNL2

(Blank)  
 .020 Polypropylene

QUANTITY	PRICE
100	\$ 18.20/ 100
1,000	\$121.20/1000
10,000	\$109.10/1000

## BHNL3

(Blank)  
 .020 Polypropylene

QUANTITY	PRICE
100	\$14.45/ 100
1,000	\$96.40/1000
10,000	\$86.75/1000

\$15.00 handling fee for orders under \$200.00.

Call us today for your custom handle quote!

Unless paid at the time of order placement, orders paid for by credit card will receive a 3% surcharge.

We can create a custom design or adapt your existing art files. Call Macore for a sample to test with your pack size. We'll quote any size project you have. Customers will be drawn to your colorful presentation and you'll make it easy for them to carry it home!



Tiny blue star-shaped flowers. Blooms all summer. Ideal for rockeries, borders, and pavers.



## Standard Push-On Tags

For your shrubs, gift, holiday and other potted products, you can't go wrong with a Macore push-on tag. The different attaching styles below provide a sure fit under outside conditions (Q) or a gentle holding action for indoor products (H). Whatever the setting, either tag is also easy to turn and read.

These tags are:

- Printed on strong 19pt. – 20pt. styrene
- Includes attractive art
- Able to be modified

Our size selection will help you get just what your product needs. Lift your product presentation with our push-on tags!

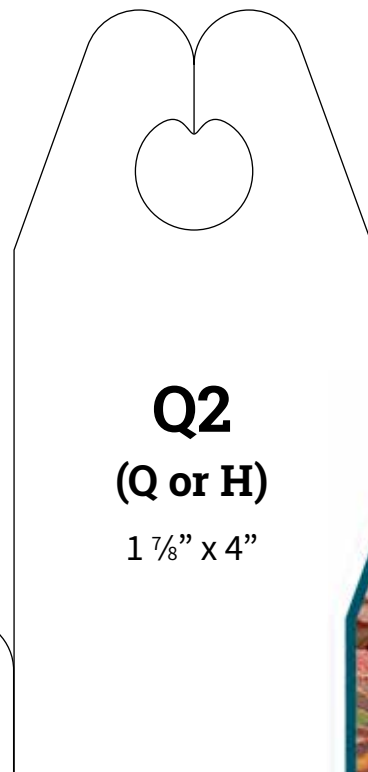
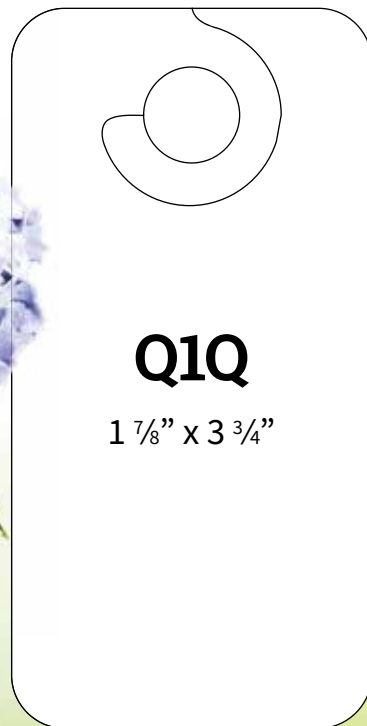

See the  
Trees & Woody  
Ornamentals  
Lister for standard  
varieties available.



## R1

(Full Color)

## R0

(Black Ink Only)

Printed on one side

1" x 3 3/4"

R1 & R0 available only in size and attachment shown.

## ATTACHMENTS

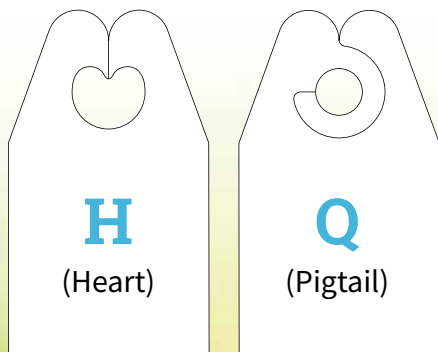

## Q1Q

(Q Attachment Only)

1 7/8" x 3 3/4"

QUANTITY	PRICE PER 1000
4,000	\$91.85
8,000	\$88.95
12,000	\$87.55
16,000	\$71.00
24,000	\$67.90
48,000	\$62.90

■ 4,000 minimum total order.

## Q3

(Attachment Q or H)

1 7/8" x 5"

QUANTITY	PRICE PER 1000
3,000	\$145.00
6,000	\$136.90
12,000	\$133.50
18,000	\$121.50
36,000	\$ 88.55
48,000	\$ 81.30

■ 3,000 minimum total order.

## R0

Black Ink Only / 1-Sided

1" x 3 3/4"

QUANTITY	PRICE PER 1000
<9,000	\$37.50
9,000	\$28.35
18,000	\$26.25
36,000	\$25.20
54,000	\$22.70
108,000	\$21.75

## Q2

(Attachment Q or H)

1 7/8" x 4"

QUANTITY	PRICE PER 1000
4,000	\$91.20
8,000	\$88.05
12,000	\$87.10
16,000	\$70.05
24,000	\$67.10
48,000	\$62.10

■ 4,000 minimum total order.

## R1

Full Color

1" x 3 3/4"

QUANTITY	PRICE PER 1000
<9,000	\$39.10
9,000	\$31.75
18,000	\$31.30
36,000	\$30.55
54,000	\$29.90
108,000	\$28.65

■ All tags require 500 per variety multiple.

■ All Push-On tags (except R0) are printed in high quality color.

■ \$15.00 handling fee for orders under \$200.00.

■ Call us for a quote on large quantities or custom orders!

■ Unless paid at the time of order placement, orders paid for by credit card will receive a 3% surcharge.

All prices F.O.B. from Lafayette, Oregon. Prices subject to change without notice.

## Standard Hang Tags

Your retail clients and their customers will love the attractive and informative Macore Standard hang tag. Designed with our own custom artwork, each tag has complete variety information on the back. These tags use a large photo frame resulting in a strong plant image. They also are:

- Made with strong HDPE material
- Have rich colorful printing
- Able to modify per grower needs
- Order with or without string

Call us today so we can help you with any hang tag need!



**N3S**  
(String)

**N3N**  
(No String)

3 ¼" x 5 ⅞"

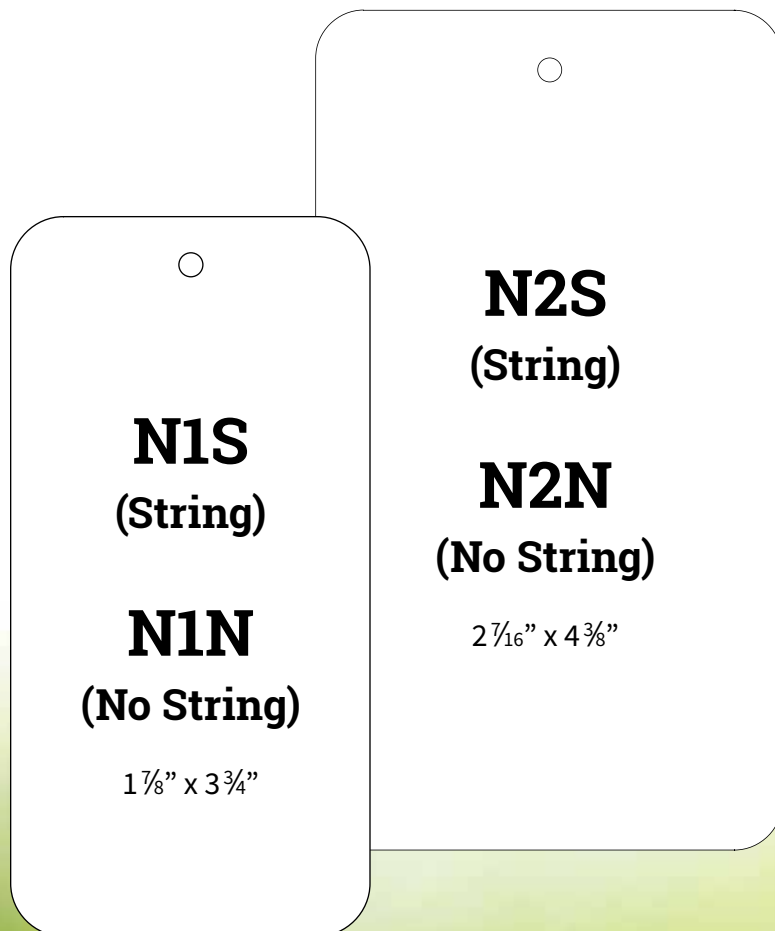

## Standard Hang Tags

### N1S

(String)

1 7/8" x 3 3/4"

QUANTITY	PRICE PER 1000
6,000	\$118.35
12,000	\$110.40
25,000	\$ 83.95
50,000	\$ 73.25
100,000	\$ 64.15

- 6,000 total order minimum / multiple.
- Above 24,000 no order multiple.

### N2S

(String)

2 7/16" x 4 3/8"

QUANTITY	PRICE PER 1000
8,000	\$122.55
16,000	\$108.55
18,000	\$104.00
36,000	\$ 91.20
72,000	\$ 78.50

- 8,000 total order minimum / multiple to 16,000.
- 9,000 order multiple above 16,000.
- Above 36,000 no order multiple.

### N3S

(String)

3 1/4" x 5 1/8"

QUANTITY	PRICE PER 1000
9,000	\$170.80
12,500	\$144.25
25,000	\$131.30
50,000	\$110.60
100,000	\$109.95

- 9,000 total order minimum.
- 11,500 order multiple after 9,000 up to 23,000.
- Above 36,000 no order multiple.

### N1N

(No String)

1 7/8" x 3 3/4"

QUANTITY	PRICE PER 1000
6,000	\$98.20
12,000	\$90.10
24,000	\$65.80
50,000	\$53.40
100,000	\$44.55

- 6,000 total order minimum / multiple.
- Above 24,000 no order multiple.

### N2N

(No String)

2 7/16" x 4 3/8"

QUANTITY	PRICE PER 1000
8,000	\$102.70
16,000	\$ 88.55
18,000	\$ 83.35
36,000	\$ 71.10
72,000	\$ 58.65

- 8,000 total order minimum / multiple to 16,000.
- 9,000 order multiple above 16,000.
- Above 36,000 no order multiple.

### N3N

(No String)

3 1/4" x 5 1/8"

QUANTITY	PRICE PER 1000
9,000	\$149.85
12,500	\$124.00
25,000	\$111.45
50,000	\$ 90.60
100,000	\$ 90.20

- 9,000 total order minimum.
- 11,500 order multiple after 9,000 up to 23,000.
- Above 36,000 no order multiple.

All tags require 500 per variety multiple.

All Standard Hang Tags are printed in high quality color.

\$15.00 handling fee for orders under \$200.00.

Call us for a quote on large quantities or custom orders!

Unless paid at the time of order placement, orders paid for by credit card will receive a 3% surcharge.

**Look your Best!**



All prices F.O.B. from Lafayette, Oregon. Prices subject to change without notice.

## Seasonal Specialty Tags

### Mother's Day Tags

You'll find the help you need with the most important nursery weekend of the year. You'll also help your retail clients shine with the person who's dear to us all – moms! These tags present beautiful Mother's Day artwork that will be a joy to both give and receive.

Our economical **Series One** tags (at right here) are stocked on the shelf here at Macore. They have beautiful front artwork but are blank on the back. They can work with virtually any product and easily accept a sticker (UPC, etc.) on the back.

**This holiday deserves our full attention!**

### MDAY1

1 1/4" x 4 3/4"



### MDAY2

2 1/8" x 5 5/8"



**Look your Best!**





### MDAY4

1 15/16" x 7 1/2"



### MDAY3

3 7/8" x 9 7/16"



### MDAY1

Styrene  
1 1/4" x 4 3/4"

QUANTITY	PRICE
100	\$ 4.30/ 100
1,000	\$34.20/1000
5,000	\$32.50/1000

### MDAY2

Styrene  
2 1/8" x 5 5/8"

QUANTITY	PRICE
100	\$ 7.60/ 100
1,000	\$60.70/1000
5,000	\$57.65/1000

### MDAY3

HDPE  
3 7/8" x 9 7/16"

QUANTITY	PRICE
100	\$ 26.55/ 100
1,000	\$212.50/1000
5,000	\$201.90/1000

### MDAY4

HDPE  
1 15/16" x 7 1/2"

QUANTITY	PRICE
100	\$ 14.90/ 100
1,000	\$119.15/1000
5,000	\$113.20/1000

\$15.00 handling fee for orders under \$200.00.

Call us for a quote on large quantities or custom orders!

Unless paid at the time of order placement, orders paid for by credit card will receive a 3% surcharge.

All prices F.O.B. from Lafayette, Oregon. Prices subject to change without notice.

# Seasonal Specialty Tags

## Mother's Day Tags

Our **Series Two** tags are electronically set-up to use with any variety. We'll create them (nominal variety fee) using the right photo & date, even your photo if you wish.

**MH2**

1 15/16" x 7 1/2"



**MB4**

2 1/8" x 5 5/8"



**MH5**

1 7/8" x 9 7/16"



**MH1**

1 13/16" x 4"



**MB2**

1 1/4" x 4 3/4"



**MN2**

2 7/16" x 4 3/8"



## MB2

(Styrene)

1 1/4" x 4 3/4"

QUANTITY	PRICE PER 1000
<6,500	\$65.55
6,500	\$52.65
13,000	\$51.50
26,000	\$45.05
52,000	\$44.75

## MH2

(HDPE)

1 15/16" x 7 1/2"

QUANTITY	PRICE PER 1000
9,000	\$135.75
18,000	\$ 87.40
36,000	\$ 76.55
72,000	\$ 64.45
144,000	\$ 61.75

- 9,000 minimum total order.
- 9,000 multiples up to 54,000.
- Multiples waived over 54,000.

## MN2S

(String - HDPE)

2 7/16" x 4 3/8"

QUANTITY	PRICE PER 1000
8,000	\$133.00
16,000	\$117.35
18,000	\$111.50
36,000	\$ 97.50
72,000	\$ 83.75

- 8,000 total order minimum/multiples to 16,000.
- 9,000 multiple above 16,000.
- Above 36,000 no order multiple.

## MB4

(Styrene)

2 1/8" x 5 5/8"

QUANTITY	PRICE PER 1000
<5,000	\$124.95
5,000	\$102.30
10,000	\$ 95.95
20,000	\$ 94.35
40,000	\$ 80.25

## MH5

(HDPE)

3 7/8" x 9 7/16"

QUANTITY	PRICE PER 1000
3,500	\$359.80
7,000	\$225.35
14,000	\$191.80
28,000	\$158.20
56,000	\$149.80

- 3,500 minimum total order with multiples of 3,500.

## MN2N

(No String - HDPE)

2 7/16" x 4 3/8"

QUANTITY	PRICE PER 1000
8,000	\$113.00
16,000	\$ 97.40
18,000	\$ 91.60
36,000	\$ 77.90
72,000	\$ 64.15

- 8,000 total order minimum/multiples to 16,000.
- 9,000 multiple above 16,000.
- Above 36,000 no order multiple.

## MH1

(HDPE)

1 7/8" x 4"

QUANTITY	PRICE PER 1000
4,000	\$181.95
8,000	\$102.50
12,000	\$ 96.80
24,000	\$ 70.10
48,000	\$ 58.55

- 4,000 minimum total order with multiples of 4,000.

All tags require 500 per variety multiple.

\$15.00 handling fee for orders under \$200.00.

Call us for a quote on large quantities.

Unless paid at the time of order placement, orders paid for by credit card will receive a 3% surcharge.



All prices F.O.B. from Lafayette, Oregon. Prices subject to change without notice.

## Custom Tags and Labels

You can have beautiful custom tags to match the quality of your product. Whether your need is complex or simple, Macore staff will help design the label you want. Your design can be adapted to work with any available shape or we can help you create a totally new look.



Look your Best!



OPTION **1**

## Our Shape, Your Design

Bring us your art and then choose one of our shapes. Macore has many shapes available to put your existing artwork on. This includes our Standard tag shapes. We'll work with you all the way to make sure it all has your approval. See page 30 for examples.

OPTION **2**

## Your Shape, Our Design

Bring us your shape and we'll create the design you want. Macore will partner with you to develop the custom look you need to best represent your product. See page 30 for examples.

OPTION **3**

## Your Shape, Your Design

Bring us both your art and shape. We'll work with you to change your current look. The result will be a high-quality custom tag! See page 31 for examples.

OPTION **4**

## Your Ideas, Our Team

Bring us your ideas and we'll create the custom look and shape you'll be proud of! Macore can help you zero in on a look that will impress. See page 31 for examples.



# 1 Our Shape, Your Design



# 2 Your Shape, Our Design



3 Your Shape, Your Design



plant  
**WOW!**  
No Digging.  
Endless Possibilities.

Simple to Use  
Amazing Results  
NO Digging!

4 Your Ideas, Our Team



# Custom Tags and Labels

These are samples of just some available shapes. Images shown are not actual size or always proportional to each other.

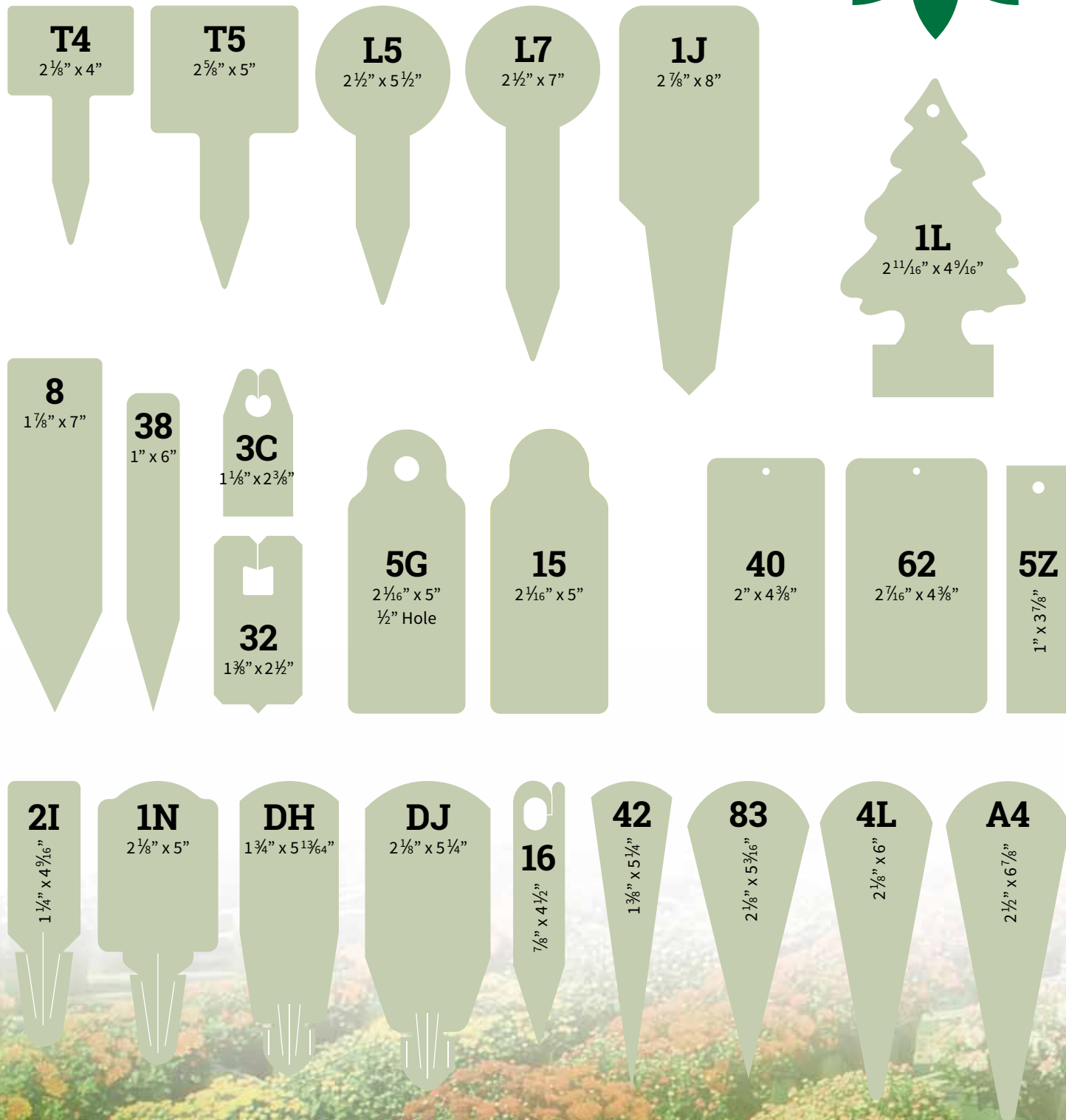



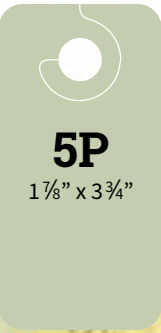
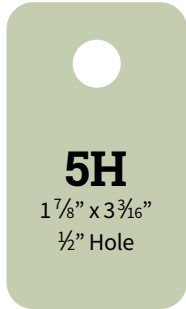
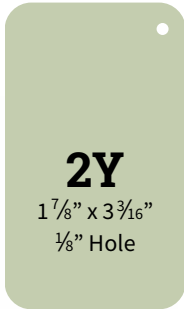
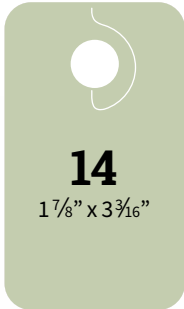
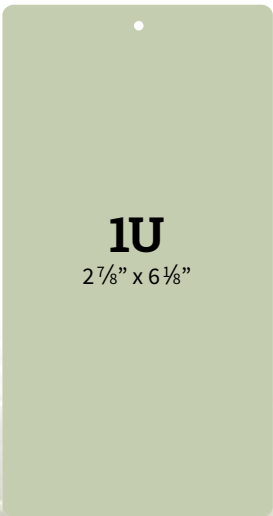
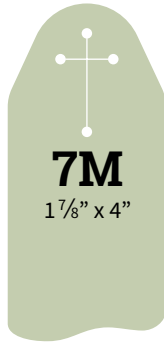
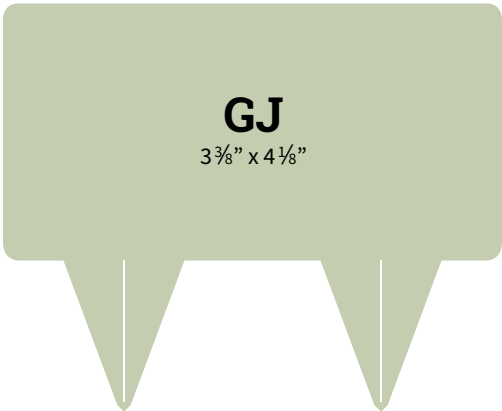
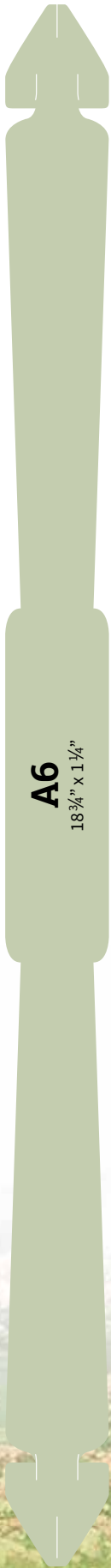

## Utility Labels with Black Ink

You may need a simple but quality tag image with just black ink on a functional size. From stakes to push-ons to wrap-arounds, Macore utility tags will impress any consumer. The layout on these products can be easily modified (see items listed on page 8). Macore also prints black ink on different plastic colors. You always need a quality presentation no matter what the setting.

**Look your Best!**



**Rudbeckia hirta** 3½-4½" double flowers Ht. 18-20"  
**MAYA** Bright golden yellow  
 Sun/light shade. Blooms July-frost if deadheaded.

## Standard Stake V5

(.019 White Styrene)

Black Ink / 1-Side

5/8" x 5"

Available as a standard item for any variety in our lister.

QUANTITY	PRICE PER 1000
<2,000	\$46.40
2,000	\$36.40
4,000	\$27.55
10,000	\$22.75
20,000	\$18.45
40,000	\$17.50

500 per variety multiple.

\$15.00 handling fee for orders under \$200.00.

\$2.50 set-up fee for each new or altered variety.

Contact Macore for custom ink color options.

Multiple plastic colors on same order are priced separately but earn a general discount when combined on same order.

Unless paid at the time of order placement, orders paid for by credit card will receive a 3% surcharge.

Call us for a quote on larger quantities or custom orders!

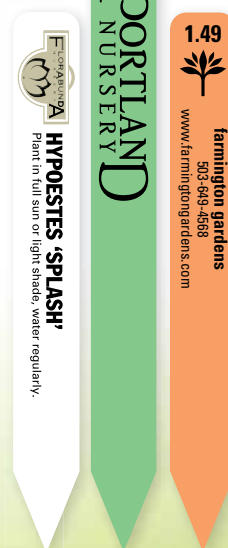

All prices F.O.B. from Lafayette, Oregon. Prices subject to change without notice.

# Custom Stake V5

5/8" x 5"

2-sided and all color Styrene orders are 1000 minimum.

1,000 MIN.

Black Ink 1 Side    Black Ink 2 Sides

QUANTITY	PRICE PER 1000	
<b>.019 White Styrene</b>		
1,000	\$63.65	
<2,000	\$46.40	
2,000	\$36.40	\$47.15
4,000	\$27.55	\$35.40
10,000	\$22.75	\$26.55
20,000	\$18.45	\$21.90
40,000	\$17.50	\$20.70

## .019 Color Styrene

1,000 minimum

Each color priced separately

1,000	\$70.90	\$113.10
2,000	\$47.40	\$ 68.70
4,000	\$34.65	\$ 46.40
10,000	\$25.10	\$ 30.10
20,000	\$20.35	\$ 24.40
40,000	\$19.40	\$ 23.10

# Optional Stake V6

5/8" x 6"

Not a standard stake but will use data from our lister to create your variety proof.

2-sided and all color Styrene orders are 1000 minimum.

1,000 MIN.

Black Ink 1 Side    Black Ink 2 Sides

QUANTITY	PRICE PER 1000	
<b>.019 White Styrene</b>		
1,000	\$69.80	\$106.25
2,000	\$49.70	\$ 67.00
5,000	\$30.25	\$ 42.25
10,000	\$22.25	\$ 29.70
20,000	\$23.35	\$ 27.80
40,000	\$21.55	\$ 22.15
80,000	\$21.05	\$ 23.40

## .019 Color Styrene

1,000 minimum

Each color priced separately

1,000	\$80.95	\$115.00
2,000	\$53.05	\$ 72.20
5,000	\$35.95	\$ 45.80
10,000	\$27.80	\$ 32.65
20,000	\$25.85	\$ 30.70
40,000	\$23.75	\$ 27.95
80,000	\$23.40	\$ 26.00

## Styrene Colors Available



(UPC codes may be hard to scan on Red & Dark Blue)

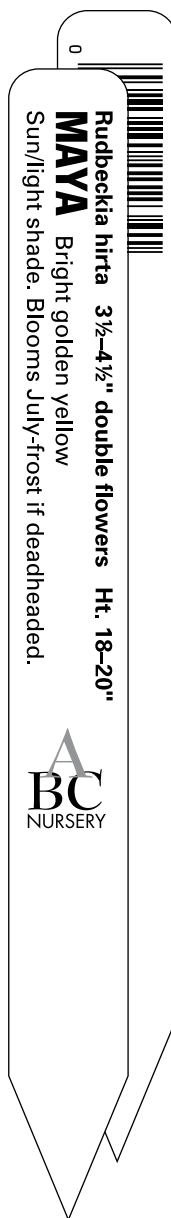
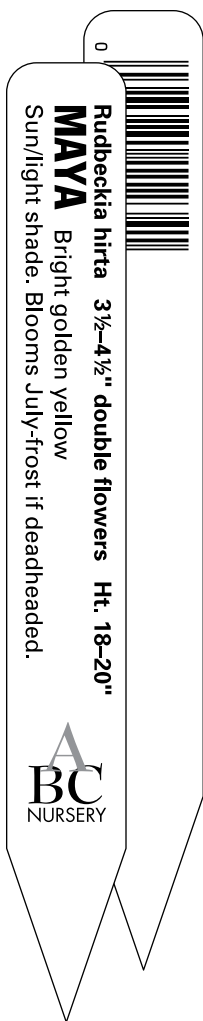

500 per variety multiple.

\$15.00 handling fee for orders under \$200.00.

\$2.50 set-up fee for each new or altered variety.

Contact Macore for custom ink color options.

Multiple plastic colors on same order are priced separately but earn a general discount when combined on same order.

Unless paid at the time of order placement, orders paid for by credit card will receive a 3% surcharge.

All prices F.O.B. from Lafayette, Oregon. Prices subject to change without notice.

# Utility Labels with Black Ink

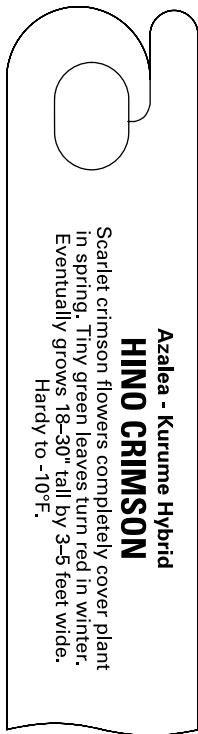

## Push-On R0

(.019 White Styrene)  
Black Ink / 1-Side  
1" x 3 3/4"

**Azalea - Kurume Hybrid**  
**HINO CRIMSON**  
 Scarlet crimson flowers completely cover plant in spring. Tiny green leaves turn red in winter. Eventually grows 18-30" tall by 3-5 feet wide. Hardy to -10°F.

QUANTITY	PRICE PER 1000
>9,000	\$37.50
9,000	\$28.35
18,000	\$26.25
36,000	\$25.20
54,000	\$22.70
108,000	\$21.75

All prices F.O.B. from Lafayette, Oregon. Prices subject to change without notice.



**Azalea - Kurume Hybrid**  
**HINO CRIMSON**  
 Scarlet crimson flowers completely cover plant in spring. Tiny green leaves turn red in winter. Eventually grows 18-30" tall by 3-5 feet wide. Hardy to -10°F.

## Custom R0

1" x 3 3/4"

2-sided and all color Styrene orders are 1000 minimum.

QUANTITY	PRICE PER 1000	
	Black Ink 1 Side	Black Ink 2 Sides
<b>.019 White Styrene</b>		
1,000	\$86.40	
2,000	\$57.85	
3,000	\$48.75	
4,500	\$43.55	
<9,000	\$37.50	
9,000	\$28.35	\$33.30
18,000	\$26.25	\$31.20
36,000	\$25.20	\$30.15
54,000	\$22.70	\$24.55
108,000	\$21.75	\$23.55

<b>.019 Color Styrene</b>		
1,000 minimum		
Each color priced separately		
1,000	\$96.00	\$122.65
2,000	\$63.60	\$ 78.95
3,500	\$45.25	\$ 55.25
7,000	\$34.05	\$ 40.40
14,000	\$31.35	\$ 37.70
28,000	\$30.00	\$ 36.35
42,000	\$27.20	\$ 29.55

All prices F.O.B. from Lafayette, Oregon. Prices subject to change without notice.



**BC**  
 NURSERY

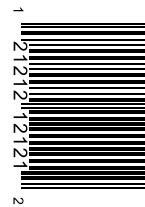

- 500 per variety multiple.
- \$15.00 handling fee for orders under \$200.00.
- \$2.50 set-up fee for each new or altered variety.
- Contact Macore for custom ink color options.
- Multiple plastic colors on same order are priced separately but earn a general discount when combined on same order.
- Call us for a quote on larger quantities.
- Unless paid at the time of order placement, orders paid for by credit card will receive a 3% surcharge.



## Styrene Colors Available

RED	LAVENDER
ORANGE	GREEN
YELLOW	LIGHT BLUE
PINK	DARK BLUE

(UPC codes may be hard to scan on Red & Dark Blue)

# Wrap-A-Round Label

## W1 or W1T

(HDPE)

3/4" X 9" (Shown at reduced size)

White High Density Polyethylene (HDPE)

Available with or without 1 1/2" tearoff at no difference in price.

This tag is a custom tag not automatically connected with the Macore variety lister.

1000 minimum order.

QUANTITY	PRICE PER 1000	
	Black Ink 1 Side	Black Ink 2 Sides
1,000	\$112.45	\$142.35
2,000	\$ 75.50	\$ 93.15
2,500	\$ 60.40	\$ 74.55
5,000	\$ 43.05	\$ 51.90
10,000	\$ 38.50	\$ 47.40
20,000	\$ 34.15	\$ 41.75
30,000	\$ 30.40	\$ 33.65
60,000	\$ 28.95	\$ 32.20

Clevera japonica  
**JAPANESE CLEYERA**  
 3 Gallon

OPTIONAL TEAROFF



# Wrap-A-Round Label

## W2 or W2T

(HDPE)

1" X 10" (Shown at reduced size)

White High Density Polyethylene (HDPE)

Available with or without 1 1/2" tearoff at no difference in price.

This tag is a custom tag not automatically connected with the Macore variety lister.

1000 minimum order.

QUANTITY	PRICE PER 1000	
	Black Ink 1 Side	Black Ink 2 Sides
1,000	\$117.75	\$147.85
2,000	\$ 78.15	\$ 95.85
4,500	\$ 49.85	\$ 59.75
9,000	\$ 44.80	\$ 54.65
18,000	\$ 39.90	\$ 48.30
36,000	\$ 38.60	\$ 47.05

**Olinda Bonsai & Ornamentals**  
 P.O. Box 1634 • Makawao, Hawaii 96768  
 Phone: 808 / 573-0808 • Fax: 808 / 871-2869

Call us for a quote on larger quantities or custom orders!

- 500 per variety multiple.
- \$15.00 handling fee for orders under \$200.00.
- \$2.50 set-up fee for each new or altered variety.
- Contact Macore for custom ink color options.
- Unless paid at the time of order placement, orders paid for by credit card will receive a 3% surcharge.

All prices F.O.B. from Lafayette, Oregon. Prices subject to change without notice.

# Blank Stakes and Tags

Macore's blank series of products gives you flexibility for different situations. Growers can use them to monitor and record stages in the production process. Retailers find them very effective in the garden center setting to inform the consumer. All our blank products are made of sturdy, dependable materials that will perform at a high level.



Images shown are not actual size or always proportional to each other.

## .019 Styrene (or Special Order .020 Vinyl)

See description for substrate available. Styrene available in white or assorted colors.

### B458

5/8" x 4"

QUANTITY	PRICE PER 1000
<b>.019 White Styrene</b>	
1,000	\$18.10
10,000	\$16.30

<b>.019 Color Styrene</b>	
1,000	\$20.00
10,000	\$18.00

Rainbow Box of 5 colors (*Orange, Green, Yellow, Lt. Blue & Lavender*): 200 per color @ \$23.00 per 1,000.

### B558

5/8" x 5"

QUANTITY	PRICE PER 1000
<b>.019 White Styrene</b>	
1,000	\$19.75
10,000	\$17.80

<b>.019 Color Styrene</b>	
1,000	\$22.00
10,000	\$19.80

Rainbow Box of 5 colors (*Orange, Green, Yellow, Lt. Blue & Lavender*): 200 per color @ \$25.00 per 1,000.

### B658

5/8" x 6"

QUANTITY	PRICE PER 1000
<b>.019 White Styrene</b>	
1,000	\$24.25
10,000	\$21.80

<b>.019 Color Styrene</b>	
1,000	\$27.00
10,000	\$24.30

Rainbow Box of 5 colors (*Orange, Green, Yellow, Lt. Blue & Lavender*): 200 per color @ \$30.30 per 1,000.

### BD1

1" x 4 1/2"

QUANTITY	PRICE PER 1000
<b>.019 White Styrene</b>	
1,000	\$24.15
10,000	\$21.75

### B55

1 3/8" x 5 1/2"

QUANTITY	PRICE PER 1000
<b>.019 White Styrene</b>	
1,000	\$40.00
10,000	\$36.00

### B6x1

1" x 6"

QUANTITY	PRICE PER 1000
<b>.019 White Styrene</b>	
1,000	\$34.70
10,000	\$31.25

Call us for a quote on large quantities or vinyl.

\$15.00 handling fee for orders under \$200.00.

Unless paid at the time of order placement, orders paid for by credit card will receive a 3% surcharge.

All prices F.O.B. from Lafayette, Oregon. Prices subject to change without notice.

# Blank Stakes and Tags



**BR1**

1" x 3 3/4"

QUANTITY	PRICE PER 1000
----------	----------------

**.019 White Styrene**

1,000 \$26.60

10,000 \$23.95

**.019 Color Styrene**

1,000 \$30.35

10,000 \$27.30

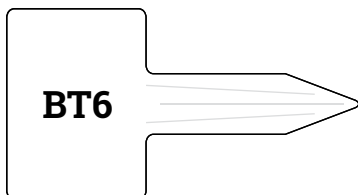

**BT6**

2 3/4" x 6" (2 3/4" x 2 3/8" Head)

QUANTITY	PRICE PER 1000
----------	----------------

**.019 White Styrene**

1,000 \$81.95

10,000 \$73.75

Call for quote on vinyl.

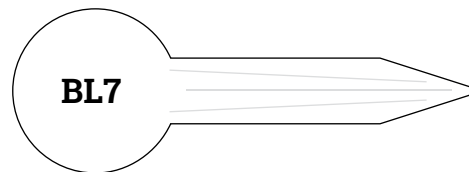

**BL7**

2 1/2" x 7" (2 1/2" Head)

QUANTITY	PRICE PER 1000
----------	----------------

**.019 White Styrene**

1,000 \$73.15

10,000 \$65.85

Call for quote on vinyl.

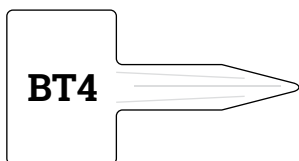

**BT4**

2 1/8" x 4" (2 1/8" x 1 1/2" Head)

QUANTITY	PRICE PER 1000
----------	----------------

**.019 White Styrene**

1,000 \$45.50

10,000 \$40.95

Call for quote on vinyl.

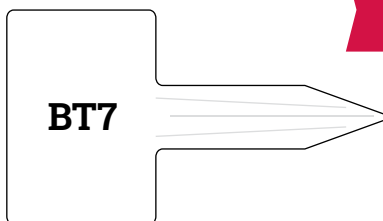

**BT7**

3 1/4" x 7" (3 1/4" x 2 3/4" Head)

QUANTITY	PRICE PER 1000
----------	----------------

**.019 White Styrene**

1,000 \$103.35

10,000 \$ 93.00

Call for quote on vinyl.

Unless paid at the time of order placement, orders paid for by credit card will receive a 3% surcharge.

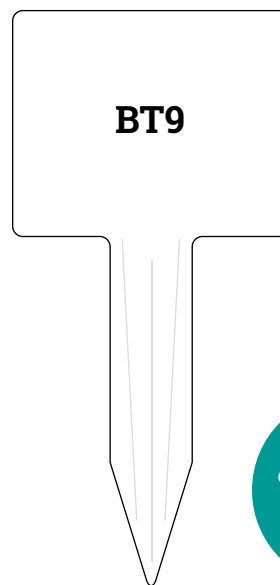

**BT9**

4" x 9 1/2" (4" x 2 3/4" Head)

QUANTITY	PRICE
----------	-------

**.019 White Styrene**

100 \$ 19.70/ 100

1,000 \$157.65/1,000

10,000 \$141.90/1,000

Call for quote on vinyl.

Call for custom print quote on all Blank sizes.

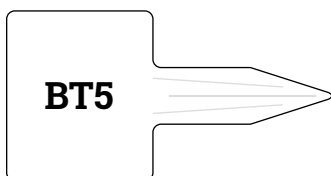

**BT5**

2 5/8" x 5" (2 5/8" x 2 1/4" Head)

QUANTITY	PRICE PER 1000
----------	----------------

**.019 White Styrene**

1,000 \$65.25

10,000 \$58.75

Call for quote on vinyl.

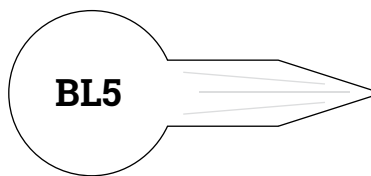

**BL5**

2 1/2" x 5 1/2" (2 1/2" Head)

QUANTITY	PRICE PER 1000
----------	----------------

**.019 White Styrene**

1,000 \$65.05

10,000 \$58.55

Call for quote on vinyl.

## Styrene Colors Available

(UPC codes may be hard to scan on Red & Dark Blue)



# Blank Stakes and Tags

## Blank Cards

White and colors of one size can mix in 100 multiples for quantity pricing.

### B5070

7" x 5"

QUANTITY	PRICE
<b>White Styrene</b>	
100	\$ 19.15/ 100
1,000	\$153.05/1000

<b>Color Styrene</b>	
100	\$ 22.05/ 100
1,000	\$176.35/1000

### B5570

7" x 5 1/2"

QUANTITY	PRICE
<b>White Styrene</b>	
100	\$ 22.10/ 100
1,000	\$176.75/1000

<b>Color Styrene</b>	
100	\$ 25.50/ 100
1,000	\$204.00/1000

### B7011

11" x 7"

QUANTITY	PRICE
<b>White Styrene</b>	
100	\$ 38.35/ 100
1,000	\$306.70/1000

<b>Color Styrene</b>	
100	\$ 45.65/ 100
1,000	\$365.35/1000

White and Colors of one size card may be mixed in 100 multiples for quantity price.

\$15.00 handling fee for orders under \$200.00.

Call us for a quote on large quantities or custom orders.

Unless paid at the time of order placement, orders paid for by credit card will receive a 3% surcharge.

All prices F.O.B. from Lafayette, Oregon. Prices subject to change without notice.

### Styrene Colors Available



(UPC codes may be hard to scan on Red & Dark Blue)





# Blank Tray Handle Straps

.020 Polypropylene used for all handles.

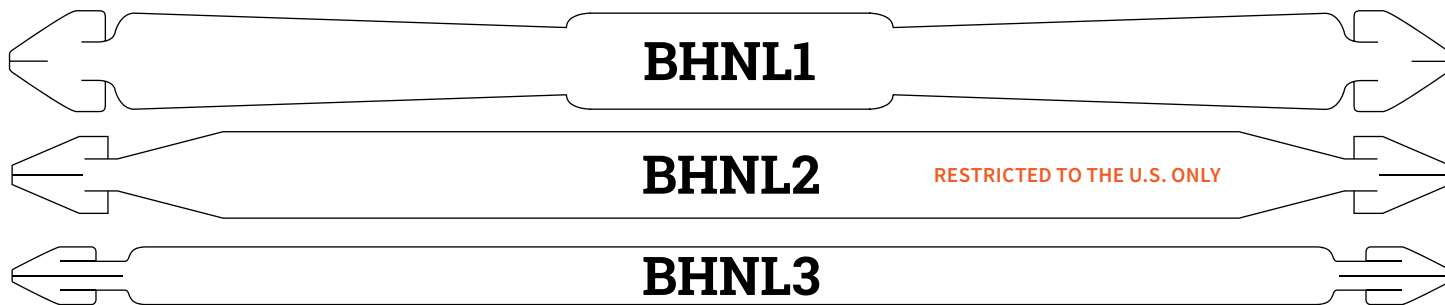

## BHNL1

1 1/4" x 18 3/4"

QUANTITY	PRICE
100	\$ 22.30/ 100
1,000	\$148.80/1000
10,000	\$133.90/1000

## BHNL2

1 1/8" x 18 3/4"

QUANTITY	PRICE
100	\$ 18.20/ 100
1,000	\$121.20/1000
10,000	\$109.10/1000

## BHNL3

3/4" x 18 3/4"

QUANTITY	PRICE
100	\$14.45/ 100
1,000	\$96.40/1000
10,000	\$86.75/1000

# Blank Wrap-A-Rounds

.010 HDPE - White High Density Polyethylene

Unless paid at the time of order placement, orders paid for by credit card will receive a 3% surcharge.

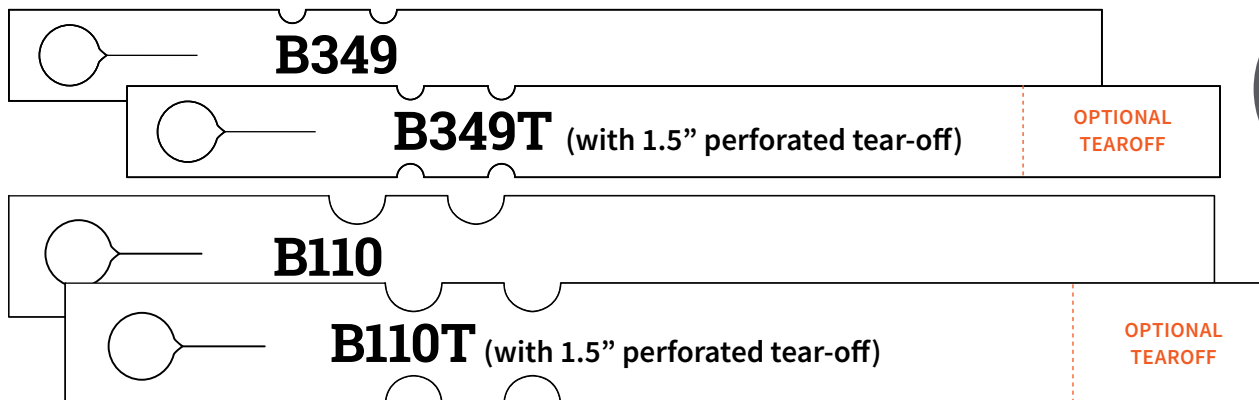

Images shown are not actual size or always proportional to each other.

## B349/B349T

3/4" x 9"

QUANTITY	PRICE PER 100
1,000	\$34.25
10,000	\$30.85

## B110/B110T

1" x 10"

QUANTITY	PRICE PER 100
1,000	\$40.60
10,000	\$36.55

Look your Best!

All prices F.O.B. from Lafayette, Oregon. Prices subject to change without notice.

# Molded Plastic Read-EZ-Tilt

Heavy Duty 60 mil. Call for orders of custom colors, minimums, and needed lead time involved.



Reinforced  
Head &  
Stake

Top Tilted  
for Easy  
Viewing



Unless paid at the time of order placement, orders paid for by credit card will receive a 3% surcharge.

## RE10

3 1/2" x 10" (3 7/16" x 2 7/16" panel)

QUANTITY	PRICE
<b>White</b>	
100	\$ 38.60/ 100
500	\$ 36.90/ 100
1,000	\$335.55/1000
5,000	\$302.00/1000

<b>Color</b>	
100	\$ 42.05/ 100
500	\$ 40.20/ 100
1,000	\$365.55/1000
5,000	\$329.00/1000

Apply total combined order quantity for all Read-EZ-Tilt 10" in multiples of 100 to pricing scale for white stakes and pricing scale for color stakes.

## RE17

6" x 17" (4 3/8" x 5 15/16" panel)

QUANTITY	PRICE
<b>White</b>	
100	\$ 78.30/ 100
500	\$ 71.75/ 100
1,000	\$652.40/1000
5,000	\$587.15/1000

<b>Color</b>	
100	\$ 81.90/ 100
500	\$ 75.05/ 100
1,000	\$682.40/1000
5,000	\$614.15/1000

Apply total combined order quantity for all Read-EZ-Tilt 17" in multiples of 100 to pricing scale for white stakes and pricing scale for color stakes.



## Molded Plastic Field Stakes

Heavy Duty 60 mil.

1 1/4" x 12"

QUANTITY	PRICE
<b>White</b>	
100	\$ 22.75/ 100
500	\$ 18.95/ 100
1,000	\$151.50/1000
5,000	\$136.35/1000

QUANTITY	PRICE
<b>Color</b>	
100	\$ 24.25/ 100
500	\$ 20.20/ 100
1,000	\$161.50/1000
5,000	\$145.35/1000

Apply total combined order quantity for all **Field Stakes** in *multiples of 1000* to pricing scale for white stakes and pricing scale for color stakes.

Unless paid at the time of order placement, orders paid for by credit card will receive a 3% surcharge.



View and download our **Garden Center Catalog** at [www.macore.com](http://www.macore.com) or call **800-331-9555**.

## Paint Pens

Oil base paint in a convenient marker.

### Fine Tip

Black (PB01), White (PW06)

QUANTITY	PRICE
1	\$4.67 each
6 or more	\$3.46 each
12 or more	\$2.94 each

### Wide Tip

Black (PB02), White (PW07)

QUANTITY	PRICE
1	\$5.64 each
6 or more	\$4.18 each
12 or more	\$3.55 each



**WORKS GREAT ON MOLDED PLASTIC!**

## Pencil

Stabilo® Aquarelle black graphite pencil for writing on plastic and other surfaces.

### Stabilo® PNL1

QUANTITY	PRICE
1	\$2.44 each
6 or more	\$2.22 each
12 or more	\$2.00 each

Unless paid at the time of order placement, orders paid for by credit card will receive a 3% surcharge.





PO Box 338  
Lafayette, OR 97127

**P** 800-331-9555

**F** 866-771-9899

**E** sales@macore.com

**Sales/Marketing Manager**

Contact:

**Mike Howden**

503-991-7245

mike@macore.com

**Pacific NW/Canada**

Contact:

**Brian Snyder**

541-405-5185

brian@macore.com



16010 0517

**Look Your Best!**  
[www.macore.com](http://www.macore.com)